

Takara standard

Takara standard

Japan, since 1912



Kitchen

Enameled Wall Panel

Enameled Washstand

System Bathroom

Shower Unit



Takara standard

樂軒 · 幸福由此開始

新北市板橋區英士路46號

2022.12

The kitchen enriches my living

為生活增添豐富多彩的廚房

讓珍愛之物恆久

堅固、雅緻、潔淨
讓您愛不釋手

無須頻繁保養清潔
也能保有潔淨及愉悅的心情

The charm of enamel

01 - Tough & Clean

As dirt does not seep into the surface, a simple wipe is sufficient to clean the kitchen. Resistant to heat, shock, and scratch. Thereby its beauty will be kept longer.

污垢不會滲入，僅需擦拭便可保持潔淨。耐熱耐衝擊，不易損傷，因而能夠長久保持美觀。



02 - Healthy

Enamel, made of inorganic metal and glass, a human-friendly material containing no harmful organic substances.

琺瑯由無機物金屬與玻璃構成，不含任何有害物質，是一種對人體友善的材料。

03 - User-friendly

Magnets can provide a new storage space, allowing the wall to be decorated freely and customized for your convenience and preferences.

利用磁鐵的特性，依照自己的使用便利性及喜好，自由自在、隨心所欲地進行收納與裝飾的配置。



04 - Communication

It is possible to use oil based marking pens on the enamel panel. As their ink can be erased with a damp cloth, the wall can be used for a message board.

琺瑯材質可用油性筆書寫，且清水即能輕鬆擦拭乾淨，也可當作留言板使用。

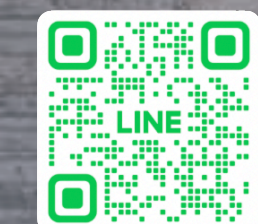



Produced with high-grade enamel. Always clean and durable.

高品位琺瑯、經久耐用、歷久彌新、永保美觀!

Dirt resistance

耐髒污



As dirt does not seep into enamel, it is easy to clean. Oil stains around the kitchen can be wiped off quickly with a damp cloth. Seasoning or cleaners adhered to the surface will not cause discoloration or deterioration.

由於髒污不會滲入，因而保養簡便。廚房內的油污，清水便可輕輕鬆鬆擦拭去除。即使沾附上調味料和洗滌劑，也不必擔心變色、變質。

Heat resistance

耐熱



High-grade enamel is resistant to high temperatures in a place around a stove that is prone to becoming hot. Even if a fire is brought close, the surface is just soiled by soot without discoloration or deterioration.

高品位琺瑯亦適用於高溫環境的爐具周圍。即使被火燒灼，也僅僅留下煙塵，不會變色、變形。

Scratch / Shock resistance

耐衝擊，不易損傷

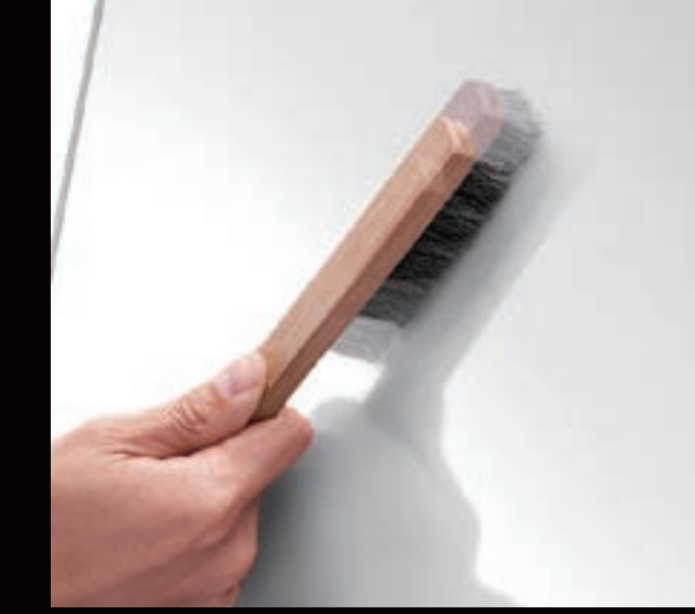

The surface will not easily become dented or scratched even if stuck with a pot or scrubbed with a stiff brush.

即使鍋具碰撞，或者用堅硬的板刷用力擦拭，也不容易出現損傷。

Safe material

安心的材質



No harmful substances such as formaldehyde that causes sick house syndrome are released. Everyone in the family can spend their time in the kitchen healthily.

不會產生可能導致病態建築症候群的甲醛等有害物質，創造確保家人健康生活的廚房空間。

The inside/outside of the kitchen cabinet are made of high-grade enamel.

廚具內外均使用高品位琺瑯



What is "high-grade enamel"?

It is a material that features both "durability of metal" and "beauty of glass".

什麼是與眾不同的“高品位琺瑯”？
兼具“鐵的堅固”和“玻璃的美觀”的材料。

Durable metal base
堅固的鐵質基材



Its durability enhances shock resistance.
堅固的鐵材發揮抗衝擊的作用。

Clean glass surface
潔淨的玻璃質



Its glass layer prevents penetration of dirt and moisture.
憑藉玻璃質阻隔髒污與濕氣。

High-Grade Enamel
高品位琺瑯

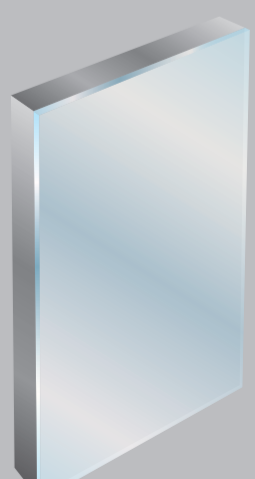

Material perfect for kitchens
形成最適於廚房的材料。

Baked at 850°C
850°C 燒結緊貼

Takara standard

樂軒·幸福由此開始





It can store sufficient kitchen utensils and also is easy to access, allowing for efficient cooking.

“不僅容量大，而且易於取放。烹飪時的操作變得更加順手。”

Enamel Inner Tray

琺瑯製內托盤

It is convenient that even wet bowls and colanders can be stored.

碗盆濾籃濕著便可歸位，非常方便。



Hidden Enamelled Compartment

門後琺瑯刀架收納盒

By opening a little, a food wrapping film etc. can be taken out of it.

保鮮膜等只需稍稍拉開抽屜便可取出。



Front Pocket

水槽前收納盒

Perfect place to store peelers, rubber bands, and other small utensils also can fit neatly into it.

這裡非常便利。最適於削皮器及橡皮筋等小物件的完美收納區！



Enamel Inner Case

琺瑯製雙層刀叉盤

The enameled inside simplifies cleaning. Removable and washable.

琺瑯製成，保養簡便。可拆下清洗。



Easy to access when needed
The functional storage system allows for quick cooking.

想用之時能夠隨時取出！憑藉功能性收納，烹飪也變得隨心所欲。



Magnet Storage / "Anywhere" Rack
磁鐵收納/隨意架

The whole wall can be used as a storage space.
The magnet racks can be moved anywhere across
the wall after they are attached.

可使整個壁板成為收納空間，設置後也可變動。



The combination of magnets and suckers allows firm attachment
to the wall. Even a heavy pot lid can also be held securely.
憑藉磁鐵與吸盤的雙重力量，固定在壁板上。即便是較重的鍋蓋，也不會掉落。



Recipe stand
菜譜架

Eye Level Rack
下拉收納盒

Pulled down to the eye level
only when needed.

能夠僅在使用時下拉至眼前高度



Eye Level Rack Drain Type
下拉式瀝水盤

Attaches firmly
to the wall

固定在壁板上



Magnet 磁鐵

Sucker 吸盤

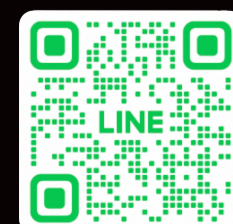

Takara standard

樂軒·幸福由此開始

Kitchen Series Lineup

 LEMURE



 Treasia



 Edel

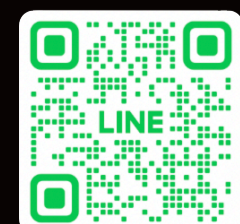

When I stand here in the kitchen, I get inspired.
Ideas come to me one after another, and I feel excited.
Equipped with only features of genuine worth,
the kitchen is perfect for me.

站在這裡，靈感獲得啟發。
思路不斷湧現，心靈躍動。
這就是屬於我“真正得心應手的廚房”。

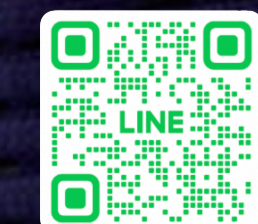



Door color: GRAYISH GREEN 櫥櫃門顏色: GRAYISH GREEN

Door color: GLOSS DARKBLUE 櫥櫃門顏色: GLOSS DARKBLUE





Door color:GLOSS WOOD MEDIUM 櫥櫃門顏色:GLOSS WOOD MEDIUM



Door color:PEARL WHITE 櫥櫃門顏色:PEARL WHITE



Example of installation

設計範例

A simple and clean kitchen:
It reminds me one of
my favorites movies.

明亮而潔白的廚房有如置身在最喜愛的電影之中



Door color: WHITE 櫥櫃門顏色: WHITE





When I stand here,
my “switch” goes ON at the beginning of the day and OFF at the end.
Although I am busy every day, I try to treasure every single moment.
The kitchen “enhances my everyday life”.

平常的日子也變得非常特別

站在這裡，開啟、結束著每一天。

雖然每天都緊張匆忙，但希望珍惜地度過每一個瞬間。

早餐時間，全家人圍坐餐桌前，一起享用。

而晚餐時烹製幸福佳餚，讓餐桌上的話題變得更加豐富有趣。

使內心更加滿足而平靜，全家共同成長——

這就是我“在生活中追求的廚房”。

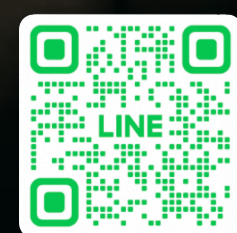



Door color: CONCRETE WHITE 櫥櫃門顏色: CONCRETE WHITE

Door color: BEIGE 櫥櫃門顏色: BEIGE



Door color: BLUE GREEN 櫥櫃門顏色: BLUE GREEN



Today I will cook one of my family's favorite meals.
The kitchen is full of sunshine pouring over the family.

舒適的感覺，是家的溫馨

站在這裡，是關愛全家人最好的位置

今天要做一頓大家都喜歡的美食。

這就是我 "充滿陽光、照耀整個家庭的廚房"。



Door color: BEIGE 櫥櫃門顏色: BEIGE



Door color: LIGHT PINK 櫥櫃門顏色: LIGHT PINK

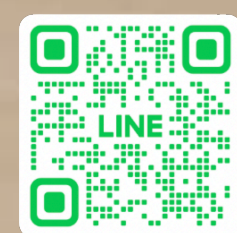

Color Variations 門板顏色選擇

◎LEMURE < All 23 colors > < 23 色可選 >

Enamel System Kitchen 琺瑯系統廚房

group1 < All 8 colors > < 8 色可選 >

A variety of high-quality door color patterns are available that faithfully reproduce the texture of pottery, ceramics, marble, and others.

圖案注重材料真實質感，展現燒制的陶瓷及大理石等風韻。



L1V: ELM NATURAL

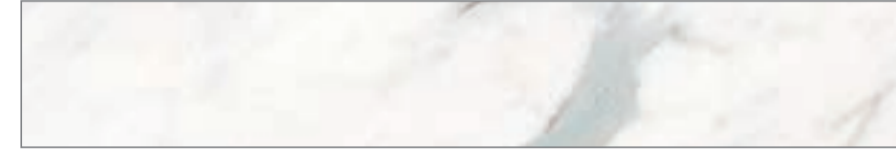

L1W: DRAMATIC WHITE



L1G: GRAYISH GREEN

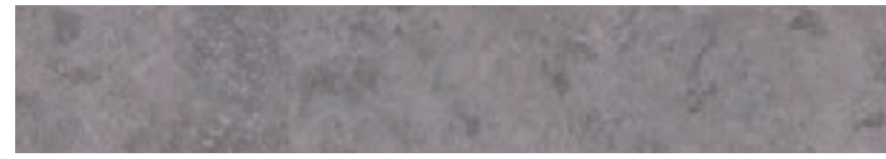

L1D: CONCRETE DARK

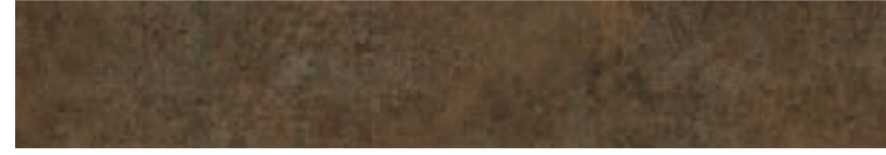

L1B: RUSTY BROWN



L1P: WHITE PORCELAIN



L1M: MARQUINA BLACK



L1S: BROWN SILK

group2 < All 3 colors > < 3 色可選 >

Gloss series of "deep" tone colors 呈現深色調的光澤系列



L1G: GLOSS WOOD DARK



L1M: GLOSS WOOD MEDIUM



L1N: GLOSS DARK BLUE

group3 < All 12 colors > < 12 色可選 >

Pearl series 珍珠系列



L1R: ROCHE PEARL ROSE



L1P: ROCHE PEARL PINK

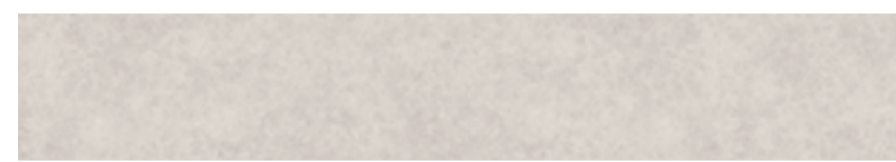

L1I: ROCHE PEARL IVORY

Clear and shiny pearl colors

華麗的珍珠光芒



L1P: PEARL BORDEAUX



L1W: PEARL WHITE

Wood tone colors with soft atmosphere 柔和氣氛的原木色調



L1X: ROSE WOOD DARK



L1W: ROSE WOOD WHITE

Semi-mat wood tone colors 半霧面木紋色調



L1C: SILKY WOOD BEIGE



L1G: SILKY WOOD GREGE

Stylish hair line patterns 時尚的細條紋



L1H: HAIR LINE BLACK



L1I: HAIR LINE IVORY

Door handles 把手



Rail-type door handle
隱藏式把手



Enamel door handle
琺瑯把手



Stainless steel door handle
不銹鋼把手
*Stainless steel door handles are not available in black.
※ 不銹鋼把手未提供黑色

Colors of door molding 門框顏色

Door molding/handles are available in silver or black.

櫥櫃門框及把手顏色可選擇銀色或黑色。



Silver
銀色



Black
黑色

◎Treasia < All 18 colors > < 18 色可選 >

Enamel System Kitchen 琺瑯系統廚房

group1 < All 11 colors > < 11 色可選 >



VTG: CONCRETE GRAY



VAU: ANTIQUE BRONZE



VWW: WALNUT WHITE



VPP: PEARL PINK



VTW: CONCRETE WHITE



VBW: MIX WOOD WHITE



VWV: WALNUT GRAIGE

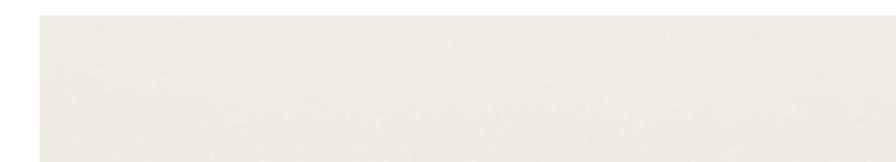

VPI: PEARL IVORY



VAK: ANTIQUE BORDEAUX



VBB: MIX WOOD DARK



VWQ: WALNUT BLACK

group2 < All 7 colors > < 7 色可選 >



VSQ: BLACK

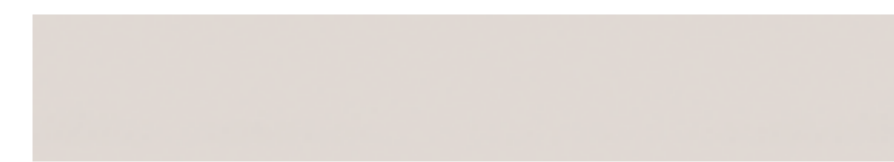

VSI: FLORAL IVORY



VSW: WHITE



VSJ: BLUE GREEN



VSB: BROWN

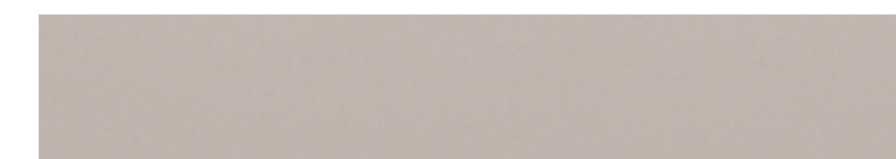

VST: BEIGE



VSD: LIGHT PINK

Door handles 把手

Two types of door handles are available: one is an easy-to-grip, rail-type door handle, and the other is a door handle capable of gripping tightly for opening or closing the door easily. The door handle color is silver or black, the same as the door's side-molding color.

可提供 2 種把手，一種為便於手拉動的隱藏式把手，另一種是能夠牢牢握住開閉的橫桿把手。配合門框顏色，把手的顏色可選擇銀色或黑色。



Rail-type door handle
隱藏式把手



Aluminum door handle
橫桿式把手



Silver
銀色



Black
黑色

Colors of door molding/handles

櫥櫃門框・把手顏色

Door molding/handles are available in silver or black.

櫥櫃門框及把手顏色可選擇銀色或黑色。

◎Edel < All 7 colors > < 7 色可選 >

Enamel System Kitchen 琺瑯系統廚房



ESD: LIGHT PINK



ESN: DARK BLUE



Cloisonné door handles are simple in design and easy-to-use. The large drawers can be pulled out easily due to the easy-to-grip handles.

簡潔的櫥櫃門設計，搭配易於使用的景泰藍把手。

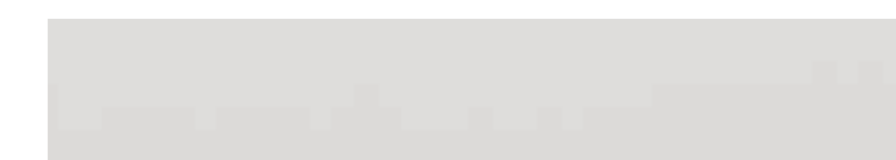

ESF: LIGHT GRAY



ESW: WHITE



EST: BEIGE



ESB: BROWN

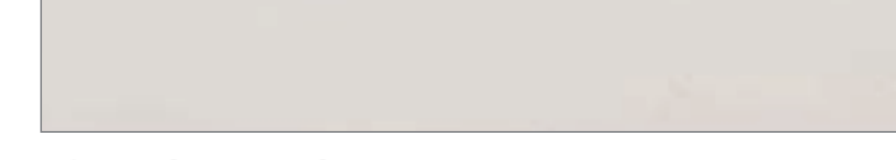

ESI: FLORAL IVORY

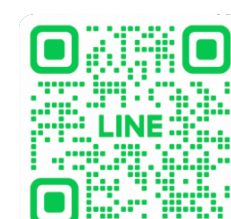

ENAMELED CABINET 琺瑯櫃體

◎LEMURE

Select the units you prefer
可自由挑選的櫃體

Choose from a number of easy-to-use components, combined to suit your storage needs and activities.
可依收納量和使用方法自由組合，規劃方便使用的廚房。



Soft-closing function 緩衝關閉功能



Sufficient length of drawer provides large storage space.
抽屜可拉到底，收納空間大。

Select the right height
可供選擇的高度

Select one of four levels, to suit your own height needs.

Having the right work surfaces for your height makes long meal prep times easier.

根據身高不同，有四種廚房高度可供選擇。
配合身高的高度，可讓長時間的料理工作更加輕鬆。



Work top is not included.
不含檯面。
The type of height 86cm is only available for LEMURE.
86cm僅對應LEMURE

Select door handles
可選把手

A rail type of door handle and two types of door handles with sufficient usability and designability are available.

除了軌道把手之外，還有兩種使用性佳和設計美觀的把手。



Enameled door handle 琺瑯把手
A sense of unity is produced by making the door handle and the door the same color.
與門板顏色相同呈現一體感



Stainless door handle 不鏽鋼把手
* The door of the uppermost drawer of cooking cabinet has a rail-type door handle.
※調理台櫃的最上層為軌道把手。

L-Shape Corner Cabinet (with 65cm depth) L型轉角櫃(深度65cm型)

90cm width 寬90cm



Rotary shelves enable to access easily, offering abundant storage capacity.
容易存取的旋轉櫃收納量也很豐富。



Wagon type 推車櫃
To make full use of the corner space of kitchen, a corner cabinet and a triangle rotary shelf are equipped. These units provide excessive space to store.
充分使用廚房角落部分的轉角櫃，也附有三角旋轉架，可多功能收納。

105cm width 寬105cm



A slide cage is mounted in the upper space and a rotary shelf in the lower space.
採用上層為拉籃，下層為旋轉板。



Sink cabinet 水槽下櫃

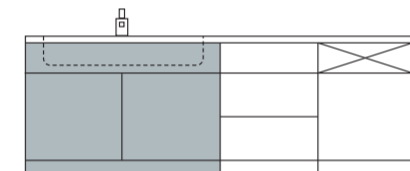

Foot-Slide type
足元抽屜款式



Slide type
抽屜款式



Door type
開門款式



Cooking cabinet 料理台櫃

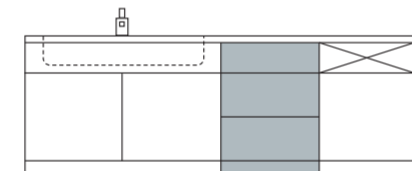

Foot-Slide type
足元抽屜款式



Slide type
抽屜款式



Two-stage drawer type
兩層抽屜式



Three-stage drawer type
三層抽屜型

Stove cabinet 爐台櫃

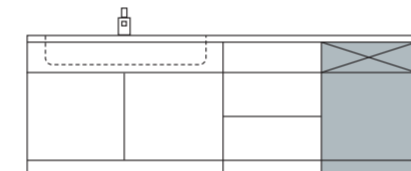

Foot-Slide type
足元抽屜款式



Slide type
抽屜款式



Inner tray
琺瑯製內托盤



Magnet-type rack is standard-equipped.
煎鍋磁性架為標準配備

Type without a grill 無烤爐

Slide type
足元抽屜款式



Option 選配件



Cabinet with Ladle/Bottle Rack 瓶罐收納櫃
Width: 15cm 寬15cm

End panel 側板



LEMURE has a type of panel of extensive height, which prevents water from spilling out of the end of the panel.

LEMURE可挑選防水濺的加高側板

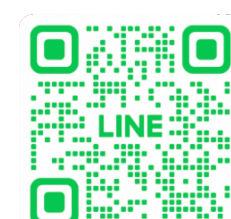

◎ LEMURE

■ Available as standard 標準配備

Enamelled Compartment 門後琺瑯刀架收納盒

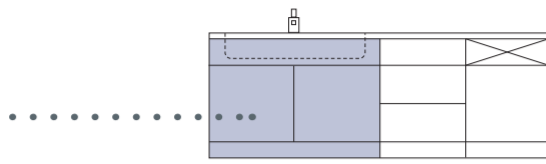

The inside of the box is also enamelled. This allows for the use of magnet-type partitions.
門板內側也為琺瑯，可以用磁鐵自己製作配件。

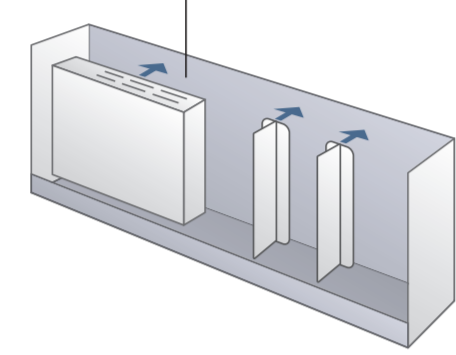

* Come as standard with sink cabinets. ※水槽下櫃裡有設置一處標準配備。
* Not available with door-type cabinets. ※開門櫃無法對應。

Front Pocket 水槽前收納盒

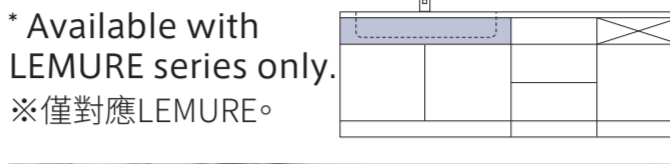

* Available with LEMURE series only.
※僅對應LEMURE。



A mini-storage box for small items, located in front of the sink.
水槽前側為方便取出的小物收納盒。

Side cover for drawer 抽屜用側蓋



* The side cover may not be attached depending on the types and conditions of cabinets.
※根據櫃體裝設狀況，有些抽屜無法設置。

Enamel rack 底部琺瑯收納架



* The enamel rack is only attached to the inside of drawer equipped under the dishwasher of Foot Slide type.
※可對應水槽下可裝設洗碗機的足元抽屜款式。

■ Option 選配

Enamel inner case 琺瑯製雙層刀叉盤

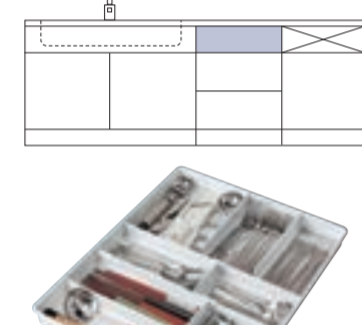

The enamel inner case allows for organizing small items easily.
琺瑯材質的櫃內收納盒可放小物品。

Magnet case partitioner allows for partitioning the enamel inner case freely.
收納盒有磁鐵的分隔架，可自由組合。

Enamel inner slide 琺瑯製內抽



* The enamel inner slide is equipped in combination with the enamel inner case.
※與琺瑯製雙層刀叉盤成套設置。

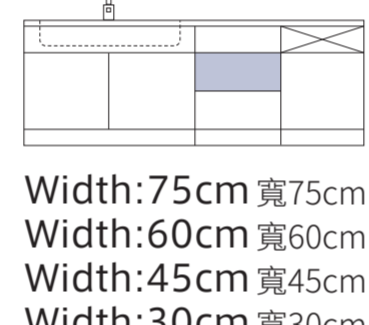

One drawer is enough to store.
抽屜本體收納容量非常大。

Enamel tray 琺瑯製內托盤



Effective use of kitchen's empty space allows for increasing its storage capacity drastically. The enamel tray moves in and out quickly along with the drawer.
有效活用空間，大幅增加收納容量。與抽屜連結，可平順開關。



* The enamel tray is not available for Door type.
* The enamel tray is standard-equipped with Slide type.
※開門櫃無法對應。
※抽屜櫃為標準配備。

◎ Treasia

■ Available as standard 標準配備

Hidden Enamelled Compartment 門後琺瑯刀架收納盒

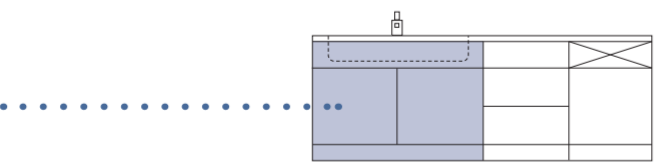

The inside of the box is also enamelled. This allows for the use of magnet-type partitions.
門板內側也為琺瑯，可以用磁鐵自己製作配件。

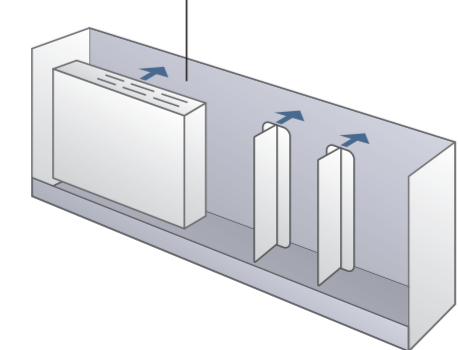

* Come as standard with sink cabinets.
* Not available with 90cm width under-sink dishwasher cabinets.

※水槽下櫃有設置一處標準配備。
※水槽下可裝設洗碗機款式之寬90cm的水槽下櫃無法對應。

■ Option 選配

Enamel tray 琺瑯製內托盤



Effective use of kitchen's empty space allows for increasing its storage capacity drastically. The enamel tray moves in and out quickly along with the drawer.

有效活用空間，大幅增加收納容量。與抽屜連結，可平順開關。



◎ Common to all series 全系列共用

L-Shape Corner Cabinet (with 65cm depth) L型轉角櫃 (深度65cm型)

■ Available as standard 標準配備

90cm width 寬90cm



Rotary shelves enable easy access, offering abundant storage capacity.
旋轉櫃所以容易取出，收納量也很豐富。
* Edel has different specifications. ※Edel的規格不同。

105cm width 寬105cm

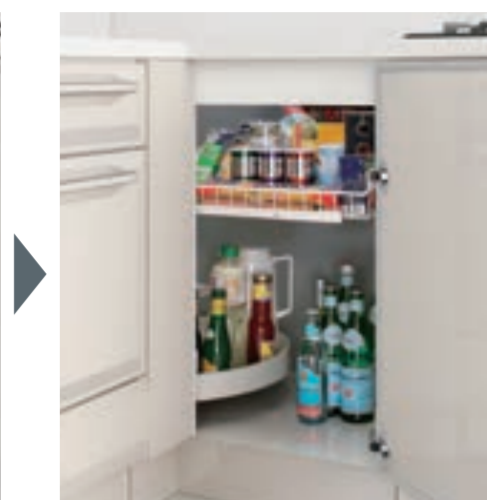

A slide cage is mounted in the upper space and a rotary shelf in the lower space. 採用上層為拉籃，下層為旋轉板。

* Edel has different specifications.
※Edel的規格不同。

■ Option 選配

Foot-Slide type (with swing-out slide basket) 足元抽屜款 (附拉籃)



Available series: Treasia
對應系列: Treasia

Large cabinets for Cooking and Stove cabinets (Foot-Slide types)
大容量櫃為料理台櫃與爐台櫃 (足元抽屜款)



Sufficient length and space
確保有寬廣的抽屜空間
Available series: Treasia
對應系列: Treasia

Cabinet with Ladle/Bottle Rack 烹飪用具、瓶子收納櫃



Available series: All series
對應系列: 全系列

Oven cabinet (Slide type) 爐台櫃抽屜型



Available series: Edel
對應系列: Edel

Two-stage Slide type with a small inner drawer inside the drawer 附櫃內抽屜兩層抽屜櫃



Available series: Edel
對應系列: Edel

Available for Edel with soft-closing function
※對應緩衝關閉規格

Tightly fitted, the adjustment fillers eliminate gaps between cabinets and walls. Width adjustment filler

消除牆壁與櫃體的縫隙，恰好符合尺寸。

尺寸調整用補板

Enamelled adjustment filler fills in the spaces of base cabinets or wall cabinets. This filler makes it possible to adjust kitchen width in accordance with customer's kitchen room size. Available width size is from 2cm to 14cm by 1cm.

調整上下櫃體與牆壁之間空隙作用的補板。
補板寬度以 2cm~14cm 為限，以每 1cm 為單位可做調整；
15cm 以上可使用拉籃櫃。
使櫃體轉角不留縫隙，是為了防止小蟲子和灰塵侵入，進而保持櫃體乾淨、衛生。

Enamelled adjustment filler
調整空隙作用的補板

Adjustment filler is not available for long type wall cabinets.

* 超長型的上櫃沒有對應的補板。

These components are used to fill the gap at the corner when installing an L-shaped kitchen around a structural pillar in a corner.

在 L 型廚房之中，如果彎角部分建有支柱，則可利用此部件進行對應。

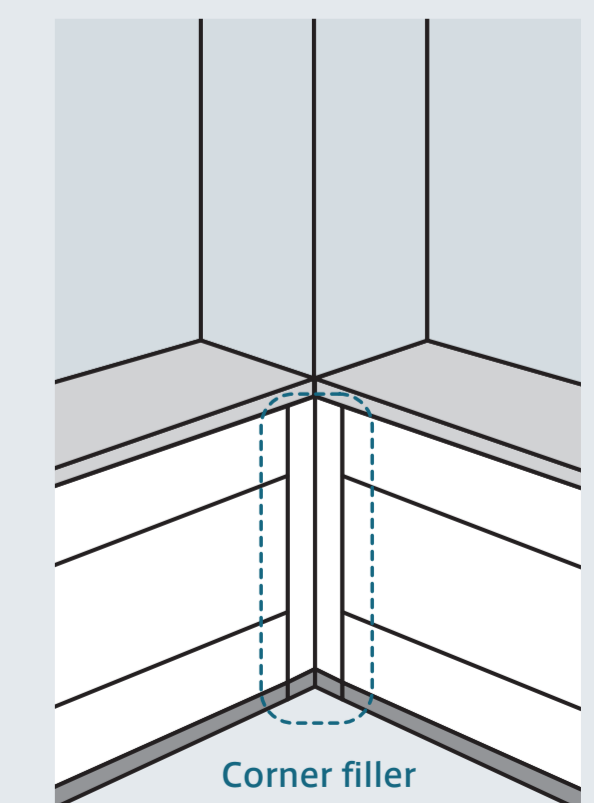

Corner filler

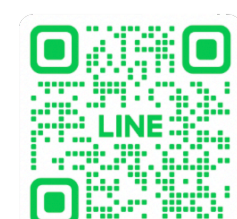

Stainless Steel Sink 水槽 (SUS304)

Utility Sink E type 機能型 E 水槽

Three-level sinks make washing, cooking, and tidying-up easier.
三層式水槽使「清洗、烹調、收拾」得心應手。

* Not available with 60cm depth cabinets.
※深度60cm型無法對應。

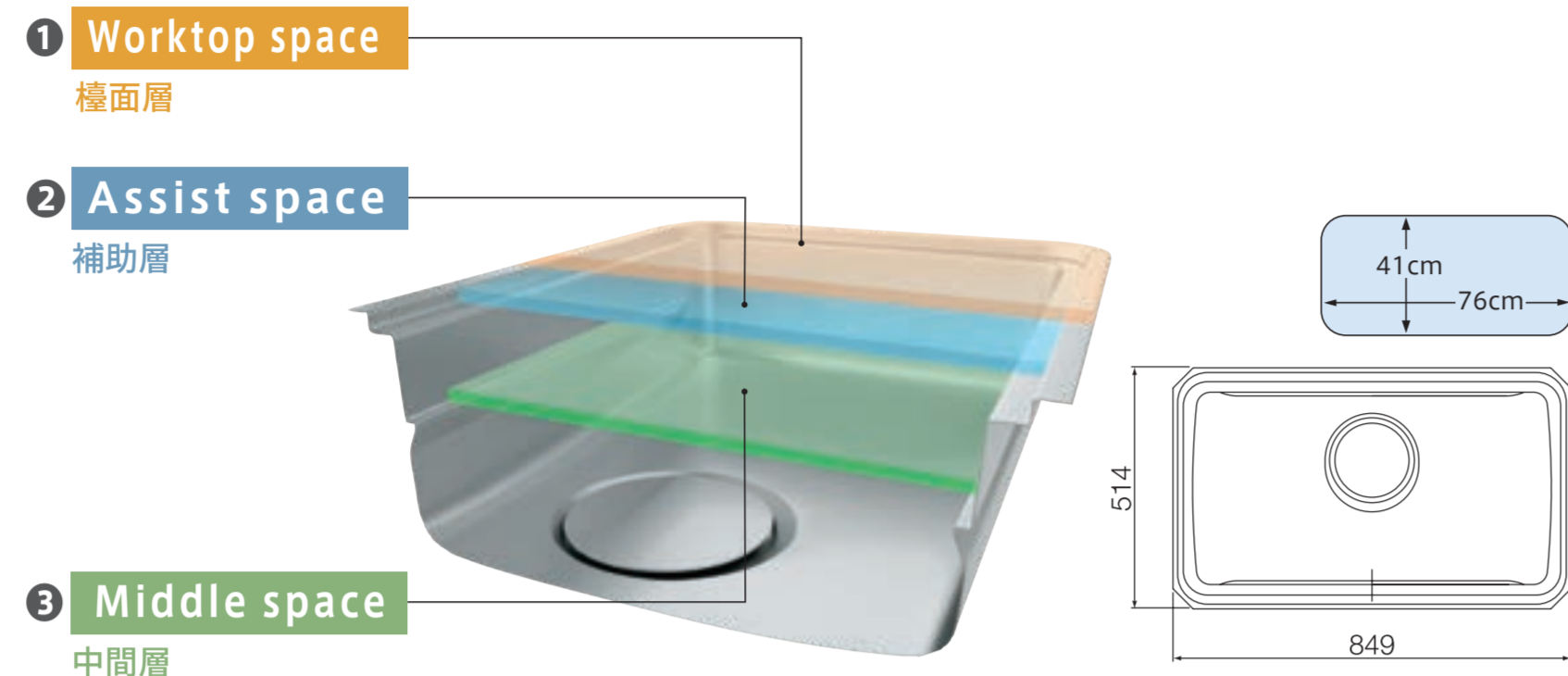

Placing the chopping board makes it easy to cut hard vegetables by applying more force on them.

放置砧板在這個高度的話，切較硬的蔬菜時會比較容易出力。



Rinse boiled pasta right into the sink. No worries about stains. Kitchen work stays neat and clean.

傾倒煮義大利麵等的熱水時，不用擔心弄髒水槽，非常乾淨。

Three levels with different characteristics make various tasks more comfortable.
利用特徵不同的三個空間，使各式各樣的烹調更輕鬆。

1 Increased work space 擴大做菜空間

Worktop space 檯面層

Option 選配



SK Drainage Board USE
SK瀝水盤USE

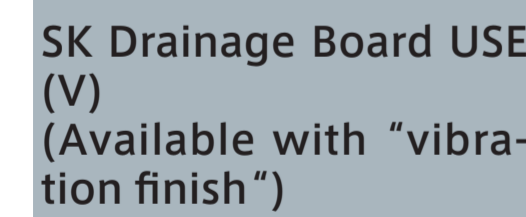

SK Drainage Board USE (V)
(Available with "vibration finish")
耐刮痕加工 SK瀝水盤USE (V)

2 Improved work efficiency 提高工作效率

Assist space 補助層

Option 選配



Chopping Board USE
砧板USE



Chopping board USE-H (synthetic rubber)
砧板USE-H(合成塑膠材料)

The impact of the knife blade is soft, dry quickly, and hygienic. Not only does the blade have a good contact and is easy to dry, but it is also very hygienic.



Drainage Rack USE (A)
瀝水籃USE(A)



Kitchen waste pocket USE
垃圾收集網籃USE

3 Efficient use of middle space 有效利用水槽的中間層

Middle space 中間層

Option 選配

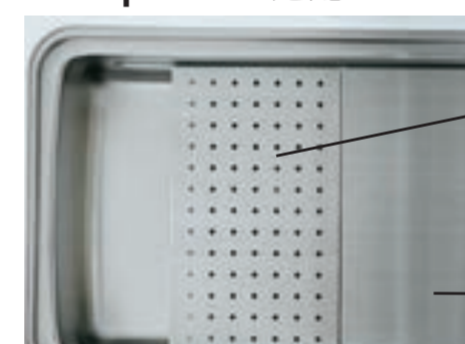

Middle-Space Drainage Board USE
中間瀝水盤USE



Middle-Space Cooking Board USE
中間料理用盤USE



Drainage net USE (A)
瀝水籃USE(A)



Detergent Rack USE
洗潔劑籃USE

* The boards with "vibration finish" have (V) at the end of their product number.
※耐刮痕加工品會在品號尾碼加上(V)。

Able to install in assist space and middle space

可設置在補助層與中間層



Drainage net USE (A)
瀝水籃USE(A)



Detergent Rack USE
洗潔劑籃USE

The installed dispenser will not interfere with the sliding of the plate.
中層的附屬配件即便移動上層，配板也不會發生碰撞。

Other options 其他選配



SK Detergent Rack
SK清潔劑籃



SK Board Stand
SK水槽配板立架



Water Stopper V
止水蓋V

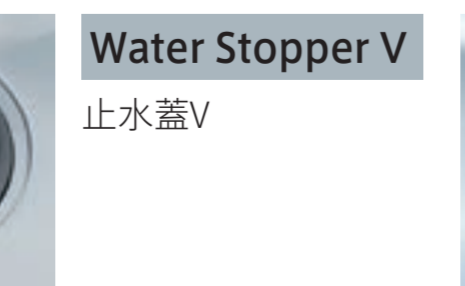

Water Stopper
止水蓋

Stainless Steel Sink 不鏽鋼水槽

Raku-L sink 樂L水槽

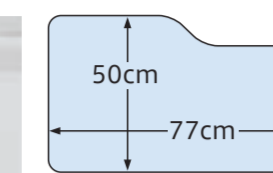

Optional accessories for User-Friendly L Sinks [樂L水槽專用選配]



The drainage board can be placed upside down. This allows you to put a chopping board on it, thus expanding the cooking space.
翻過控水架，上面可擺置砧板，擴大操作空間。

1 You CAN customize the sink the way you want it.

① 可隨心所欲搭配使用！

A small-item holder or other accessories can be hooked to the L-shaped bar.



2 You CAN wash even a large frying pan with ease.

② 較大的平底鍋也可輕鬆清洗！



3 With the L-shaped bar, you can EASE your dish washing routine.

③ L型桿使家務事變得輕鬆！

The small-item holder can slide aside, allowing you to clean the sink easily. The L-shaped bar is detachable and easy to clean.

可改變雜物架的位置，輕鬆地進行清洗。L型桿可取下，方便進行清洗保養。

4 You CAN keep the sink clean.

④ 保持清潔



Z Sink z水槽



Z-sink options 專用選配



Drainage Board Z (stainless steel)
瀝水盤Z(不鏽鋼製)

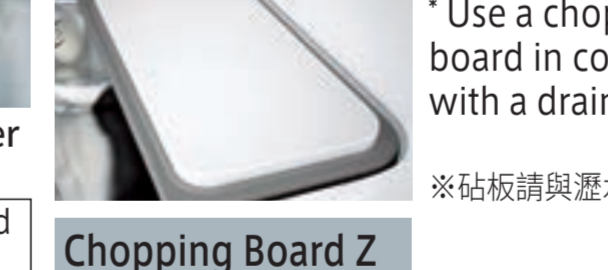

Drainage Board ZT (stainless steel)
瀝水盤ZT(不鏽鋼製)



Chopping Board Z
砧板Z

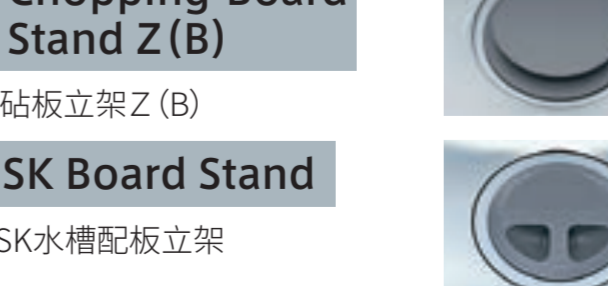

Small Utensil Holder
小物籃
Available as standard 標準配備

ZM Sink ZM水槽

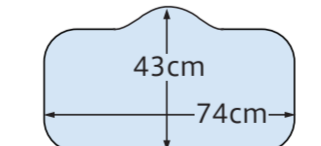

ZS Sink ZS水槽

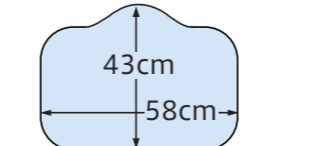

ZM-sink/ZS-sink options 專用選配

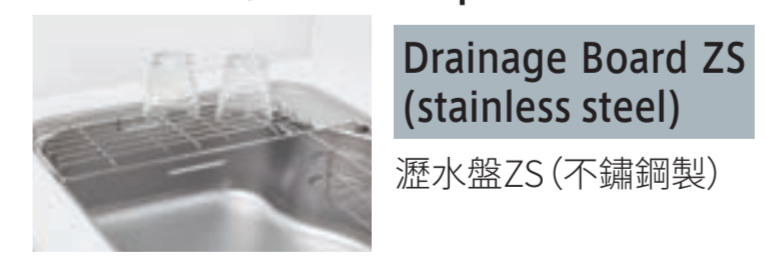

Drainage Board ZS (stainless steel)
瀝水盤ZS(不鏽鋼製)



Drainage Rack ZS
瀝水籃ZS

Options available with Z, ZM and ZS sinks Z·ZM·ZS共通選配



Chopping Board Stand Z (B)
砧板立架Z (B)
SK Board Stand
SK水槽配板立架



Water Stopper V
止水蓋V



Water Stopper
止水蓋

Y Sink y水槽



Y-sink options 專用選配



SK Drainage Board TI (Available with stainless steel worktops)
SK瀝水盤TI(對應不鏽鋼檯面)



Drainage Rack N(S)
瀝水籃N
* Can also be used with S sinks.
※也可對應S水槽。

S Sink S水槽

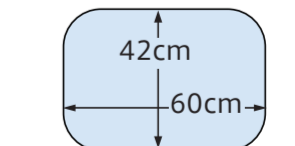

F Sink F水槽

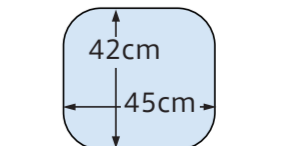

Options available with Y, S and F sinks Y·S·F共通選配



Drainage Rack S(S)
瀝水籃S(S)



SK Board Stand
SK水槽配板立架



Water Stopper
止水蓋

Enameled Kitchen Panel 琺瑯廚房壁板

Enamel is the most suitable material for kitchen equipment.

琺瑯是廚房設備最理想的材質



The base of the Kitchen Panel is made of metal and magnets can be attached. Various kinds of small magnet items convenient to be attached to the high-grade porcelain enamel are available.

底材為金屬，可使用磁鐵附件。

在此為您準備了各式各樣的便利磁吸小物，可以吸附在高品質的琺瑯上。



Benefit 特點



The hard and smooth surface allows smear to be quickly wiped off, thus ensuring everlasting cleanliness.

表面堅硬平滑可輕易擦拭髒污，清潔容易。



Enamel is not damaged even by scrubbing wire brush.

使用鋼刷刷洗，琺瑯也不會受損。



Enamel does not fade or change in color even if exposed to high temperatures.

即使經受高溫，琺瑯也不會褪色或變色。

HD Wood grain HD木紋模樣

Reproduces natural wood grain patterns faithfully. 完整呈現天然木材的木紋。



QKW:ELM WHITE



QKG:ELM GREGE



QKV:ELM NATURAL

HD 石目 HD石目

These panels use a trendy Marquina marble pattern as a motif. 時尚的黑白跟大理石紋理主題。



QEV:MARQUINA BEIGE



QEG:MARQUINA GRAY



QEQ:MARQUINA BLACK



QDI:OYA TUFF STONE

HD Concrete HD水泥

These panels offers a concrete look that is now trending in the interior design. 時尚的混凝土內裝風格。

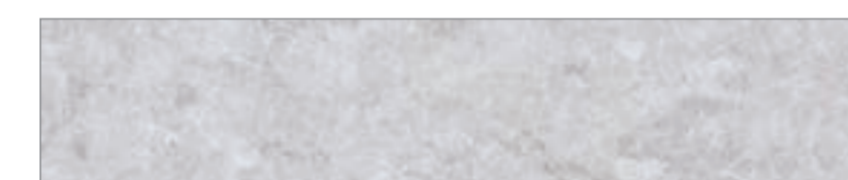

QCG:CONCRETE GRAY

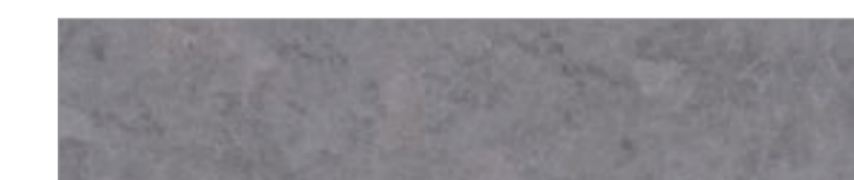

QCQ:CONCRETE DARK

HD Marble HD大理石模樣

Reproduces the marble patterns used for luxury hotels and buildings. 重現使用於高級飯店及大樓的大理石紋路。



IDW:DRAMATIC WHITE



QTW:TRAVERTINE WHITE



QTV:TRAVERTINE BEIGE

* As the patterns of panels are designed to imitate those of genuine marble stones, the color shades may vary depending on the panels.
※大理石模樣的壁板是模仿實際的石頭，所以顏色可能依壁板而有所差異。

HD Art HD藝術

Line-up of beautiful designs that colors kitchens. 裝飾美麗廚房的藝術風系列。



IMV:MOSAIC BEIGE



IMG:MOSAIC GRAY



IAG:EMBOSS TILE



QPW:WHITE PORCELAIN

Simple colors Simple colors

Simple colors make it easier to coordinate with your interior. 容易搭配室內裝潢的簡樸色調。



DWH:STONE WHITE



YWH:WOOD MILD WHITE

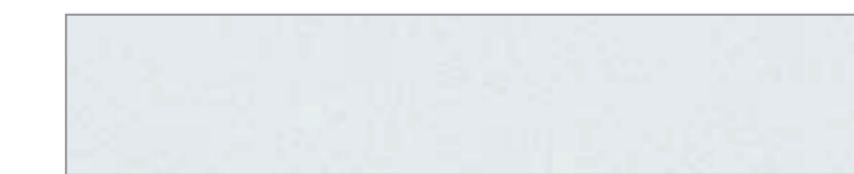

PW:PEARL WHITE

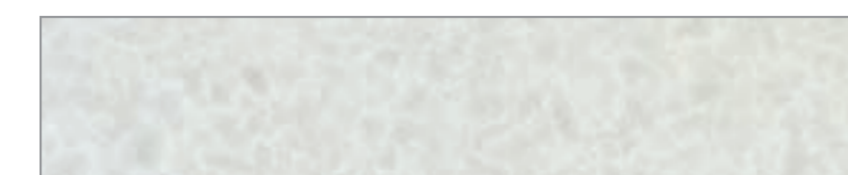

MGN:MARBLE GRAY

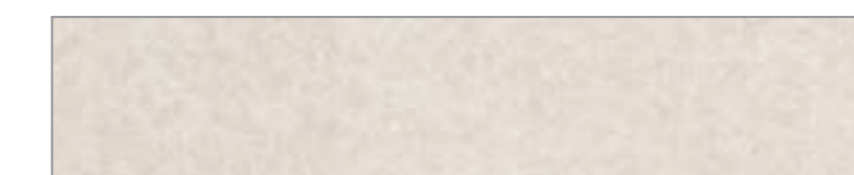

MBN:MARBLE BEIGE

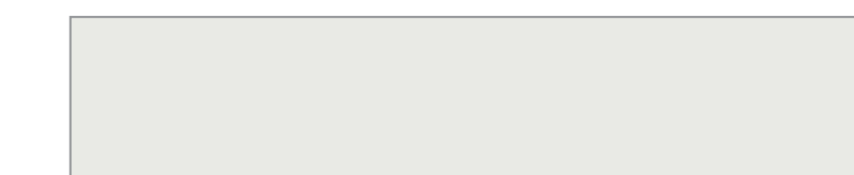

SW:WHITE

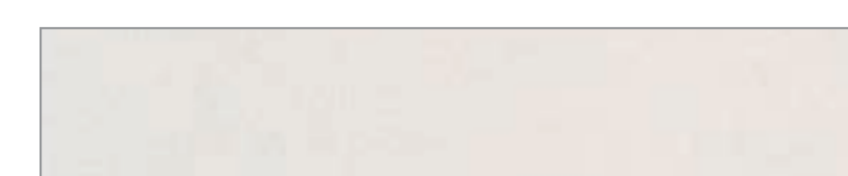

PIN:PURE IVORY

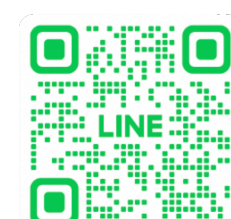

Range hood 抽油煙機



Enamel Clean Range Hood 珐瑯清潔抽油煙機

Components prone to stains are enameled. Easy to clean!

容易變髒的部分採用珐瑯，讓保養變得非常簡單！

Which components of the range hood are prone to oil stains? How prone is each such component to oil stains?

抽油煙機容易粘附油污的部位及比例

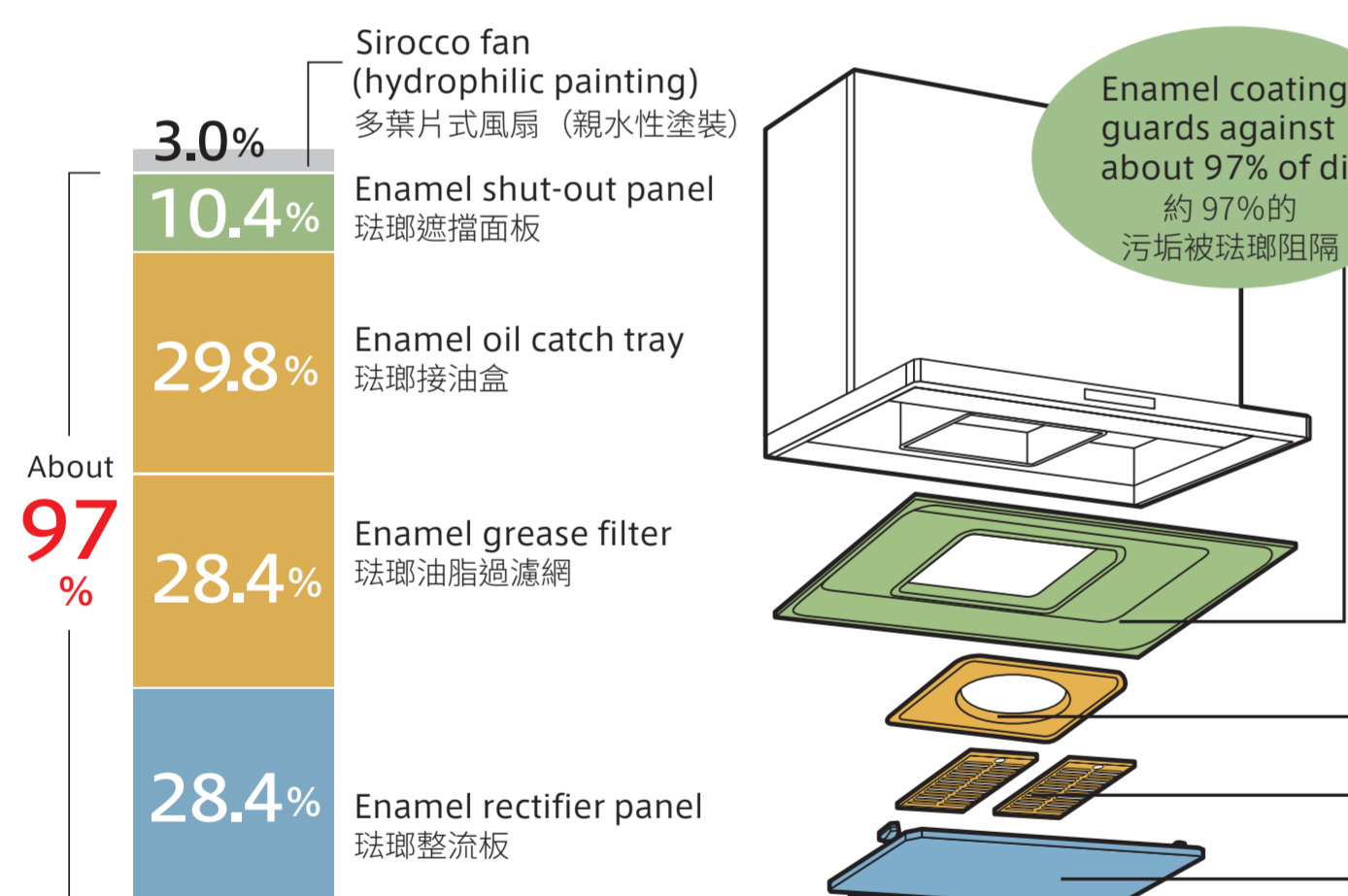

The figures given above are based on our in-house testing: Calculations were made using the experimental data obtained by measuring the amount of oil collected from each component that requires cleaning.

The total amount of oil produced was about 140g. Of that total, there was about 75g of oil collected from the surfaces of components that required cleaning. The percentages given above are based on 75g of oil.

本公司調查：根據不同保養部位油污採集實驗數據計算得出。
※產生的約140g油污之中，需要對吸排油煙機進行保養的部分上粘附的約75g油污之中的比例。

Furthermore 並且

Sirocco fan 多葉片式風扇

Hydrophilic and easy to clean dirt with water. Easily detachable with one touch!

採用水即可去除油污的親水性風扇。只需一按便可取下，操作簡便！



*The photos, illustrations, and values shown above are for VRAS type.
※照片、插圖及數值等為 VRAS 型。

Super Triple Guard 超級三重阻隔

Enamel shut-out panel 珐瑯遮擋面板

Prevents dirt from getting inside. Cleanable with a damp cloth when dirty.

遮擋污垢進入內部。即使出現髒污，用水擦拭即可潔淨如新。



The corners are free of joint gaps and easy to wipe clean. 彎角部也沒有縫隙，形狀易於擦拭。

Enamel grease filter / Enamel oil catch tray 珐瑯油脂過濾網·珐瑯接油盒

One-touch detachable, washable easily in a dishwasher.

輕輕一按便可取下，可用洗碗機輕鬆清洗。

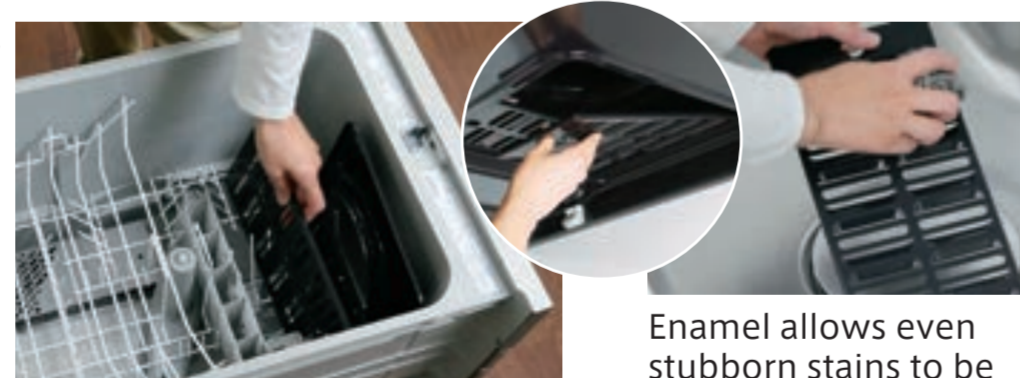

Enamel allows even stubborn stains to be scrubbed off. 因為是珐瑯，頑固的污垢也可用力擦拭清洗。

Enamel rectifier panel 珐瑯整流板

Able to clean oil stains by wiping with a damp cloth. 油污也只需用水擦拭便可去除乾淨。



Designed to create an air flow to suck the smoke easily. 產生空氣流動，容易吸入油煙的設計。

Sirocco fan (exhaust fan) 多葉片式風扇 (排氣型)

Enamel Clean Range Hood 珐瑯清潔抽油煙機



Takara's original products Takara 獨創

Super triple guard 超級三重阻隔				觸控開關	LED 照明	Operates in synch with stove 加熱器連動
Enamel shut-out panel 珐瑯遮擋面板	Enamel grease filter 珐瑯油脂過濾網	Enamel oil catch tray 珐瑯接油盒	Enamel rectifier panel 珐瑯整流板	Hydrophilic, one-touch detachable fan 輕輕一按便可取下的親水性風扇	Touch switch 保養提示 Cleaning indicator 延時計時器	



VRAE-E2AD L/R(SW/SQ)



VRAS-E2AD L/R(S)

VRAT type VRAT型



Takara's original products Takara 獨創

Super triple guard 超級三重阻隔				軟觸按鍵	Operates in synch with stove 加熱器連動
Enamel shut-out panel 珐瑯遮擋面板	Enamel grease filter 珐瑯油脂過濾網	Enamel oil catch tray 珐瑯接油盒	Enamel rectifier panel 珐瑯整流板	soft-push switch LED 照明	



VRAT-2AD L/R(V/K)



VRAT-2AD L/R(V/K)



“Mount Anywhere” Magnet Racks | Square type 隨意架 | 方型

Towel Hanger 毛巾架

■ Towel Hanger S 毛巾架S 	■ Towel Hanger L 毛巾架L 	■ Multi-Rack +Towel Hanger 多用途收納架+毛巾架 	■ Small Utensil Rack S+Hook+ Towel Hanger 小物收納架S+掛鉤+毛巾架 	■ Multi-Rack +Hook+ Towel Hanger 多用途收納架+掛鉤+毛巾架
MGSK Towel Hanger S (■) MGSK毛巾架S (■) (150×60×50mm) Maximum load: 500g 最大載重: 500g	MGSK Towel Hanger L (■) MGSK毛巾架L (■) (350×60×50mm) Maximum load: 500g 最大載重: 500g	MGAK Small Utensil Tray Rack 15S (W) + MGSK Towel Hanger L (■) MGAK小物收納架15S (W) + MGSK毛巾架L (■) (350×60×120mm) Maximum load: 1.5kg 最大載重: 1.5kg	MGAK Small Utensil Tray 15S (W) + MGAK Hook S (W) + MGSK Towel Hanger L (■) MGAK小物收納架15S (W) + MGAK掛鉤S (W) + MGSK毛巾架L (■) (350×60×80mm) Maximum load: 1.5kg 最大載重: 1.5kg	MGAK Small Utensil Tray 15S (W) + MGAK Hook S (W) + MGSK Towel Hanger L (■) MGAK小物收納架15S (W) + MGAK掛鉤S (W) + MGSK毛巾架L (■) (350×60×140mm) Maximum load: 1.5kg 最大載重: 1.5kg

Small Utensil Rack 小物收納架

■ Small Utensil Rack S 小物收納架S 	■ Small Utensil Rack M 小物收納架M 	■ Small Utensil Rack L 小物收納架L 	■ Small Utensil Rack S+ Hook 小物收納架S+掛鉤 	■ Small Utensil Rack L+ Hook 小物收納架L+掛鉤 	■ Multi-Rack 多用途收納架 	■ Multi-Rack + Hook 多用途收納架+掛鉤
MGAK Small Utensil Tray 15S (W) + MGSK Towel Hanger S (■) MGAK小物收納架15S (W) + MGSK毛巾架S (■) (150×60×55mm) Maximum load: 1kg 最大載重: 1kg	MGSK Small Utensil Rack (■) MGSK小物收納架 (■) (150×95×55mm) Maximum load: 1kg 最大載重: 1kg	MGAK Small Utensil Tray 35S (W) + MGSK Towel Hanger L (■) MGAK小物收納架35S (W) + MGSK毛巾架L (■) (350×60×55mm) Maximum load: 1.5kg 最大載重: 1.5kg	MGSK Small Utensil Hook S (■) MGSK小物掛鉤S (■) (150×60×80mm) Maximum load: 1kg 最大載重: 1kg	MGSK Small Utensil Hook L (■) MGSK小物掛鉤L (■) (350×60×80mm) Maximum load: 1.5kg 最大載重: 1.5kg	MGSK Small Utensil Holder (■) MGSK小物收納架 (■) (150×60×120mm) Maximum load: 1kg 最大載重: 1kg	MGAK Small Utensil Holder (■) + MGAK Hook S (W) MGAK小物收納架 (■) + MGAK掛鉤S (W) (150×60×140mm) Maximum load: 1kg 最大載重: 1kg

Multi-Holder 多用途掛架

■ Multi-Holder 多用途掛架 	■ Towel Hanger 抹布架 	■ Kitchen Paper Holder 餐巾紙架
MGSK Multi-Holder (■) MGSK多用途掛架 (■) (150×95×75mm) Maximum load: 1kg 最大載重: 1kg	MGSK Towel Hanger (W) MGSK抹布架 (W) (265×20×160mm) Maximum load: 200g/pc 最大載重: 平均一根 200g	MGSK Paper Holder (W) MGSK餐巾紙架 (W) (270×85×45mm) Maximum load: 250g 最大載重: 250g

Available in two colors.
有兩種顏色可供選擇。

CG: Charcoal gray W: White

* The color number is provided in the black box (■) at the end of each product number. Each product is available in two colors: CG (Charcoal Gray) and W (White).

※品號的■是顏色品號。分別有CG: 暗灰色和W: 白色, 兩種顏色可供選擇。

“Mount Anywhere” Magnet Racks 隨意架

■ Ladle Holder 烹飪用具掛架 	■ Pot Lid Holder 鍋蓋架 	■ Free Rack 任意架 	■ Recipe Stand 食譜架 	■ Chopping Board Stand 砧板立架 	■ Towel Hanger (Top surface mounting type) 抹布架(上面安裝款式) 	■ Spice Holder 調味料架
MGSK Ladle Hanger (W) MGSK烹飪用具掛架 (W) (255×39×30mm) Maximum load: 300g per hook 最大載重: 掛鉤平均一個 300g	MGSK Pot Lid Holder (W) MGSK鍋蓋架 (W) (255×142×222mm) Maximum load: 1.5kg 最大載重: 1.5kg	MGSK Free Rack (W) MGSK任意架 (W) (390×150×88mm) Maximum load: 1.5kg 最大載重: 1.5kg	MGSK Recipe Stand (W) MGSK食譜架 (W) (255×80×74mm) Maximum load: 1.5kg 最大載重: 1.5kg	MGSK Chopping Board Stand (W) MGSK砧板立架N (W) (255×75×74mm) Maximum load: 1.8kg 最大載重: 1.8kg	MGSK Towel Hanger (W) MGSK上面抹布架 (W) (155×322×26mm) Maximum load: 200g/pc 最大載重: 平均一根 200g	Spice Holder T (W) 調味料架T (W) (94×113×90mm)

“Mount Anywhere” Magnet Rack | Deluxe Type 隨意架 | 豪華型

Aluminum type 鋁材質

■ Small Utensil Rack 小物收納架 	■ Ladle Hanger 烹飪用具掛架 	■ Towel Hanger 抹布架
MGD-KR (V) (290×111×71mm) Maximum load: 1.5kg 最大載重: 1.5kg	MGD-KH (V) (290×14×52mm) Maximum load: 300g per hook 最大載重: 掛鉤平均一個300g	MGD-FH (V) (262×14×71mm) Maximum load: 200g/pc 最大載重: 平均一根 200g

Aluminum enamel type 鍍鋁琺瑯

■ Small Utensil Rack 小物收納架 	■ Ladle Hanger 烹飪用具掛架 	■ Towel Hanger 抹布架
MGH-KR (W) (290×111×71mm) Maximum load: 1.5kg 最大載重: 1.5kg	MGH-KH (W) (290×14×52mm) Maximum load: 300g per hook 最大載重: 掛鉤平均一個300g	MGH-FH (W) (262×14×71mm) Maximum load: 200g/pc 最大載重: 平均一根 200g

Eye Level Rack 下拉收納盒

System Lifting Rack “Eye Level Rack” 升降拉籃「下拉收納盒」

Eye Level Rack for LEMURE · Treasia LEMURE與Treasia專用下拉收納盒

- For 30cm width 使用寬度為30cm
- For 45cm width 使用寬度為45cm
- For 60cm width 使用寬度為60cm
- For a type with LED lighting 附有LED照明款式
- For 75cm width 使用寬度為75cm
- For a type with LED lighting 附有LED照明款式
- * Maximum load: 3kg (For 75cm: 4kg) ※最大載重為3kg (For 75cm為4kg)

Eye Level Rack for Edel Edel專用下拉收納盒

- For 30cm width 使用寬度為30cm
- For 45cm width 使用寬度為45cm
- For 60cm width 使用寬度為60cm
- For a type with LED lighting 附有LED照明款式
- For 75cm width 使用寬度為75cm
- For a type with LDE lighting 附有LED照明款式
- * Maximum load: 3kg (For 75cm: 4kg) ※最大載重為3kg (For 75cm為4kg)

Eye Level Rack for LEMURE · Treasia (L type) LEMURE與Treasia專用下拉收納盒(L型)

- For 30cm width 使用寬度為30cm
- For 45cm width 使用寬度為45cm
- For 60cm width 使用寬度為60cm
- * Maximum load: 3kg ※最大載重為3kg

Eye Level Rack for Edel (L type) Edel專用下拉收納盒(L型)

Tall utensils can be stored. 也可收納高度高的物品。

- For 30cm width 使用寬度為30cm
- For 45cm width 使用寬度為45cm
- For 60cm width 使用寬度為60cm
- * Maximum load: 3kg ※最大載重為3kg

Eye Level Rack Drain Type for LEMURE · Treasia LEMURE與Treasia專用下拉式瀝水盤

LED type LED款式

- For 75cm width 使用寬度為75cm
- For 90cm width 使用寬度為90cm
- * Maximum load: 10kg ※最大載重為10kg

Eye Level Rack Drain Type for Edel Edel專用下拉式瀝水盤

LED type LED款式

- For 75cm width 使用寬度為75cm
- For 90cm width 使用寬度為90cm
- * Maximum load: 10kg ※最大載重為10kg

Lifting Rack 油壓升降拉籃

- for 90cm front width 使用寬度為90cm
- for 60cm front width 使用寬度為60cm

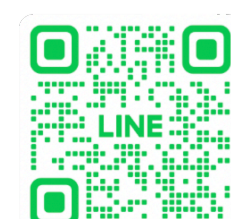

The process of creating high-grade enamel that strongly supports housework

家務的好幫手——高品位琺瑯的誕生過程

“Takara standard delivers good products.”

That is the mission of our factories.

We use our own technologies in each manufacturing process to produce strong and beautiful high-quality enamel.

“將優質產品交到用戶手中。”這是Takara standard的工廠的使命。

在每一步製造工序之中，充分發揮獨有技術，創造出堅固而美觀的高品位琺瑯。

1 Steel sheet processing 鋼板加工

Metal sheets, called steel sheets, are processed according to applications and welded by robots. For steel sheets with complicated shapes, it is difficult for robots to process them, so experienced workers will perform the work manually.

將被稱為鋼板的金屬板，根據用途進行加工，利用機械手進行焊接。複雜的形狀用機械手難以應對之時，由經驗豐富的匠人以手工作業進行加工。

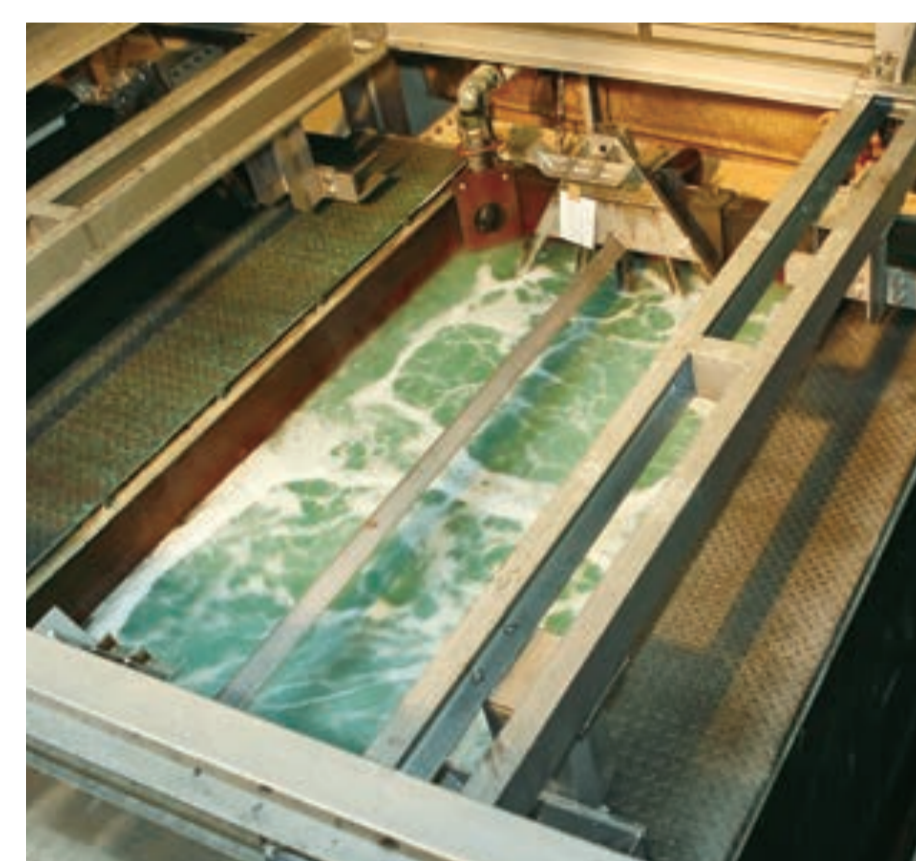

2 Preprocessing 前處理

To enhance the adhesion between the steel sheets and glaze, the steel sheets are dipped in sulfuric acid to make the surfaces finely uneven, and nickel is processed for adhering it to the steel sheets, and so on.

為了提高鋼板與釉料的接合力，施以將鋼板浸泡在硫酸之中，使其表面出現細微的凹凸狀，以及使鎳附著在鋼板上等處理。

3 Glaze manufacturing 釉料製造

The constituents of the glaze, such as silica and feldspar, are formulated and mixed at an appropriate ratio. After the constituents are fused at 1200 to 1300°C, they are cooled and hardened to form frits. Clay, water, and various other chemicals are added to the frits, which are then finely milled to form muddy glaze.

將作為釉料原料的二氧化矽及長石等，以適當的比例進行調配及混合。以1200~1300度熔融之後，再使其冷卻凝固，形成玻璃料。然後加入黏土、水及各種藥品等，細細粉碎製成泥狀釉料。



What is the enamel made of?

琺瑯是這樣的材料。

Enamel is made by spraying glassy glaze on the surface of metals such as iron and aluminum and baking the metal at a high temperature.

向鐵、鋁等金屬表面，噴塗玻璃質的釉料，再以高溫燒結形成的產品稱為琺瑯。

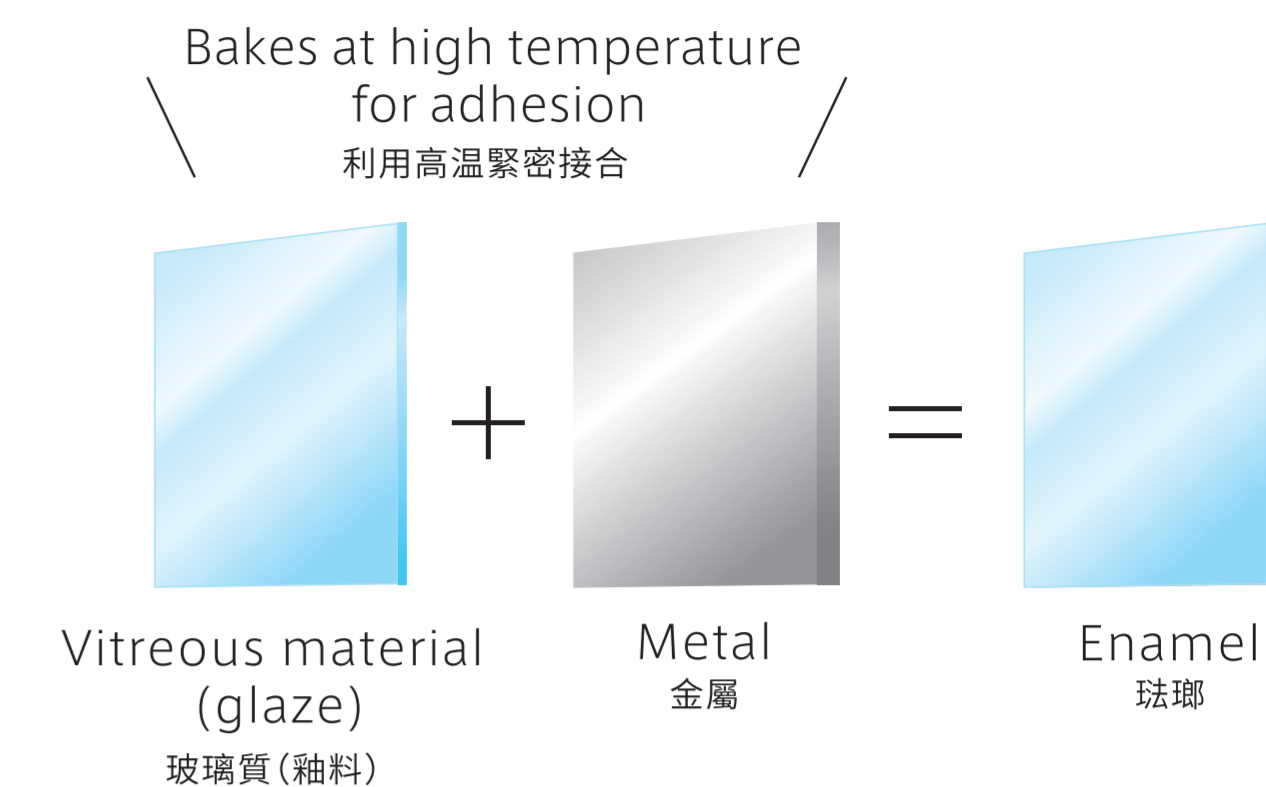

4 Glaze application 上釉

The glaze is sprayed evenly and uniformly on the pretreated steel sheets. There are a variety of glaze application methods, such as “electrostatic coating”, “spray method”, and “dipping” that is directly dipped in the glaze. We select the best method, depending on the shape and size of the parts of the products.

向經過前處理的鋼板，均勻地附上釉料。根據部件的形狀和大小，分別採用“靜電塗裝”、“噴塗方式”、直接浸泡在釉料中的“浸漬塗佈”等各種方式。



5 Glaze baking 煨燒

The finely milled glaze is baked in a baking furnace at about 850°C. When melt, the glaze grows crystals and develops colors, forming enamel with a smooth glassy surface.

在約850度的煨燒爐中進行燒結。將研磨粉碎的玻璃融化，使玻璃內結晶成長，產生顏色，製造出具有光滑玻璃面的琺瑯。

6 Finish processing 完成

After baking, each part of the products is strictly inspected: enamel thickness checking and color difference measurement. After they are assembled and cut according to applications, they are finished. After inspection and packaging are complete, they are shipped out.

對燒成的各部件，進行琺瑯膜厚核對、色差計測等嚴格的檢查。根據用途進行拼接和切割，製成完成品。之後，經過檢驗和包裝後出貨。



Notices before purchasing

[Stainless sink / Stainless steel worktop]

- Chlorine detergents (bleaches, pipe cleaners, etc.) may cause rust. Rinse thoroughly with water after use.
- Do not use chlorine type slime removers. They may cause rust of metal such as stainless steel or may deteriorate rubber or resin.
- Dragging along the surfaces of the sink/worktop the dishes, hard objects, the kitchen buckets or pots to which sand or mud are adhered, may cause scratches.
- Wipe off ingredients with high salt concentration (soy sauce, miso, etc.) adhering to the products. Leaving them adhered can cause rust.
- Do not leave wet kitchen knives or metal products (canned foods, iron products, or aluminum products, etc.) on the sink/worktop for a long time. Electrical reaction with aluminum, iron, and stainless steel may cause discoloration or rust.
- If rust or rust stains are severe, remove them by rubbing with a cream cleanser in a certain direction.
- Do not leave water splashes in the sink for a long time. Water scale may develop due to their calcium containing ingredients. Wipe them off with a cloth after use.

[Quartz stone worktop / Artificial marble worktop / Artificial marble sink]

- Since fry pans or oil pots become very hot after cooking, do not place them onto the worktop/sink directly after cooking. Cracks, discoloration, deformation (warpage) may occur. Be sure to use a pan coaster. (Note that some pan coasters may convey heat.)
- Dragging along the surfaces of the sink/worktop the dishes, hard objects, the kitchen buckets or pots to which sand or mud are adhered, may cause scratches.
- Some L-types or custom-ordered products may have joints on their worktops.

[Door / End panel / Cabinet]

- Despite the door, end panel, hood front panel and kitchen panel in the same color, variations in their colors or patterns may occur.
- Do not put a wet cloth, etc. on the door of the wooden kitchen or the end panel, or leave water drops or water spills as they are. The surface of wooden entrance may swell, or facing materials may warp, or surface materials may peel.
- Packings attached to the cabinet and door aim to relieve shock when the door is closed. They do not prevent intrusion of animals and pests.
- Enamel members has partially spots that look black such as hanging traces formed by hangers when the materials were hung or marks caused by placing the materials during manufacturing process, but having no problems on the quality.
- Since enamel members are potteries, small black spots caused on the manufacturing process may appear, but there are no problems on the quality.
- Some types of oil/water pens used to write on the products may be time-consuming to clean out depending on the time past after use. In that case, wipe them out with melamine sponges.

Be sure to read the following before purchasing.

- The casters fitted to the storage wagon may leave their traces on some types of floors.

[Range hood]

- The range hood cannot inhale sufficient oil smoke due to the wind direction of air conditioning, the ventilation system etc.
- Some IH cooking heaters cannot inhale oil smoke when installed in an open environment with little ascending air current.

[Faucets / Water purifier /Alkali ion water generator]

- Since the products are used in general households, use them only with tap water. Using hot spring water or well water (groundwater) may cause product failures due to generation of scales (chlorine component), etc.
- Check the capability of the water heaters carefully before installation. Too small outflow of water from the shower will prevent comfortable use of shower. Check the minimum necessary water pressure and maximum water pressure before using.
- Because the combination faucets undergo a large water flow resistance, the amount of hot water may become insufficient, or hot and cold water cannot be mixed smoothly, depending on the type and water pressure conditions of waterers.
- In cold climates, use the products designed for cold districts. (However, they do not prevent from freezing. If freezing may occur, perform drain work in accordance with the instruction manual.)
- The water generator is not designed for cold districts, do not install it in places where freezing may occur.
- For safe and comfortable use of the water faucet fittings, read the instruction manual well after purchasing and perform the inspection and parts replacement regularly.
 - ※ Inspect the sink area for water leakage regularly more than twice a year.
 - ※ Inspect the invisible part (especially the inside of cabinet) closely.
 - ※ Since the packing and the shower hose are consumable/wear parts, replace them periodically.
- Install the faucet with water purification function in a place where water runs once every two-three days.
 - ※ The faucet, if not used for more than two days, must be passed purified water for more than one minute before use.
 - ※ Retained water without residual chlorines is susceptible to bacterial growth. This may impair physical conditions.
- The water outflow openings of faucet fittings are each placed at different positions depending on the combination of faucet and sink. Contact our office for details.

Some items do not correspond to the items listed in the catalog.

部分項目與本目錄刊載商品無關。

購買前須知

購買前請務必詳閱。

[不鏽鋼製水槽、不鏽鋼製檯面]

- 含氯清潔劑（漂白水、水管疏通劑等）可能會導致生鏽。使用之後請用清水充分沖洗。
- 請勿使用含氯的去汙劑，以免不鏽鋼等金屬部分生鏽、橡膠或塑膠劣化。
- 拖拽食器或硬物、沾有泥沙的水盆或鍋具可能會造成刮痕。
- 殘留含鹽分較多的食品（醬油、味噌等）會導致生鏽，請擦拭乾淨。
- 請勿長時間放置沾濕的菜刀或罐頭類等的金屬產品（鐵製品、鋁製品等）。錫、鐵和不鏽鋼會產生電化腐蝕導致變色或生鏽。
- 接觸蝕鏽或生鏽嚴重時，請用去汙劑同方向研磨。
- 長時間放置濺落在水槽中的水，會因碳酸鈣導致附著水垢。水槽使用後請用布擦拭水滴。

[石英石檯面、人造大理石檯面、人造大理石水槽]

- 烹飪後的平底鍋或油鍋等因為溫度非常高，所以請勿直接放置。否則會導致出現裂痕、變色、變形（翹起）。請務必鋪上鍋墊等。（依鍋墊材質，可能會導熱，請小心。）
- 拖拽食器或硬物、沾有泥沙的水盆或鍋具可能會造成刮痕。
- L型廚房，台面可能會看到接縫。

[門板、側板、櫃體]

- 門板和側板、抽油煙機罩前面板及廚房用壁板等即使相同色系，顏色及花紋也可能會有所差距。
- 木製廚房門板或側板處請勿掛置濕毛巾等，也不要置水滴或溢出的水。否則會導致木切口突起、木材翹起、表面木材剝落。
- 櫃體及門板附有的膠條是為了緩和開門時的衝擊。並非防止動物或害蟲的入侵。
- 珐瑯部件在燒製時，會留有暗黑的吊鉤吊痕及置痕等，但不存在品質問題。
- 珐瑯部件是燒製而成，所以在製程中可能會產生小黑點，但不存在品質問題。
- 使用油性筆、水性筆時，因筆的種類或放置時間，可能需要花費時間擦拭乾淨。此時，請使用三聚氰胺海綿去除。
- 收納櫃附有滾輪，所以依地板種類，可能有滾輪痕跡留下。

[抽油煙機]

- 依空調等的風向及換氣系統等，可能會導致不易吸入油煙。
- IH調理爐因為不太會產生上升氣流等，所以開放空間有可能較難吸入油煙。

[水龍頭、淨水器、鹼性離子整水器]

- 因為是用於一般家庭，所以僅能使用自來水。若要使用溫泉水或井水(地下水)時，因會產生水垢(石灰質)而導致產品發生故障。
- 安裝時請充分確認熱水器的規格。淋浴的出水量可能會變少，導致無法暢快地使用淋浴。請確認必要的最低水壓及最高水壓後再使用。
- 冷熱混合水龍頭的通水阻力較大，所以依熱水機器的種類及水壓條件，可能無法獲得充分的熱水量，或無法順利混合冷熱水。
- 寒冷地區請使用寒冷地區規格的產品（寒冷地區規格並非防止結凍。若擔心結凍，則請按照操作說明書，進行排水作業）。
- 整水器並非是寒冷地區規格，所以請勿設置在可能會結凍的地方。
- 為了使水龍頭金屬配件能夠長期安全而舒適地使用，購買後請詳細閱讀操作說明書，進行定期點檢及更換零件。
 - ※關於定期點檢，請每年兩次以上點檢用水處是否漏水。
 - ※請特別注意看不見的部份（櫃內）。
 - ※因為膠條及淋浴軟管等為會磨損劣化的零件，所以請定期更換。
- 有淨水功能的水龍頭，請設置於兩三天可通水一次的地方。
 - ※兩天以上沒有使用時，請放流1分鐘以上之後再使用淨水。
 - ※殘留水因去除了所殘留的氯，所以很容易繁殖細菌，恐會損害健康。
- 關於水龍頭金屬配件的出水口位置，依水龍頭與水槽的組合而會有所不同。詳細位置請洽詢本公司營業處。

Company Profile 公司簡介

Takara Standard takes responsibility for guaranteeing quality and product supply as a manufacturer, ensured by an extensive production and distribution system.

Takara Standard認為，維持品質與製品供給的穩定是製造廠的責任，因此致力於整頓生產，物流體制。



Head Office/Osaka Factory 總公司・大阪工廠

Factories, Distribution Centers and Affiliates 工廠、物流中心以及相關公司

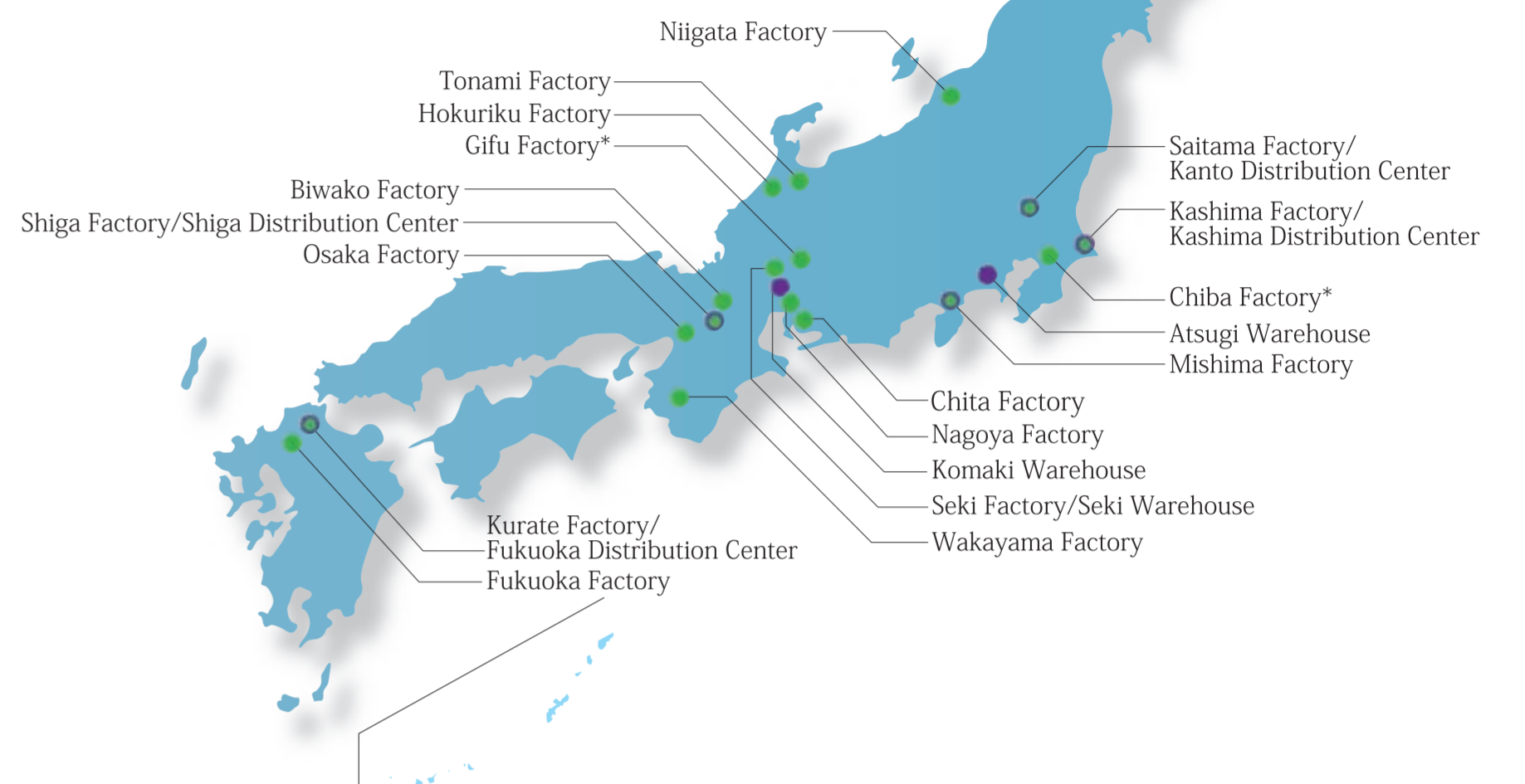

Showroom 展示中心

Approximately 170 showrooms around Japan, the most in the industry, and a broad-based training system combine to provide a strong base for sales.

在日本國內約有170間展示中心，擁有業界最多的銷售點，充實的進修制度，提升整體銷售素質。

Company History 沿革

1909 Kitahata Factory established as Japan's first enameled ironware factory.

北早田廠成立，是日本最早的漆包線五金廠。

1912 Nippon Enamel Co., Ltd., incorporated.

設立「日本Enamel株式會社」。

1945 Manufacture of enameled ironware for home use begun.

開始製造家庭用珐瑯鐵器。

1957 Japan's first stainless steel sink press developed.

日本最早以衝壓加工法成功製造不鏽鋼水槽。

1962 World first enameled kitchen developed.

成功開發出全世界最早的珐瑯廚房。

1971 Company renamed TAKARA STANDARD CO.,LTD.

公司名稱改為「Takara Standard株式會社」。

1973 Company listed on First Section of Osaka Securities Exchange.

於大阪證券交易所第一部上櫃。

1973 Company listed on First Section of Tokyo Stock Exchange.

於東京證券交易所第一部上櫃。

1977 Distribution of enameled kitchens begun.

開始生產珐瑯廚具。

1986 Distribution of enameled system kitchens begun.

開始生產珐瑯系統廚具。

1991 Achieve the sales of 100 billions yen.

營業額 日幣1000億 達成。

2012 100th anniversary since establishment.

公司創立100周年。

2013 Acquired and merged Wakayama Takara Industrial Co., Ltd. (now Wakayama Factory)

Takara Standard 股份有限公司合併和歌山實工業有限公司（現和歌山廠）。

2014 Acquired and merged Takagi Industrial Co., Ltd. (now Chiba and Gifu Factories)

Takara Standard 股份有限公司合併高木實業有限公司（現千葉工廠、岐阜工廠）。

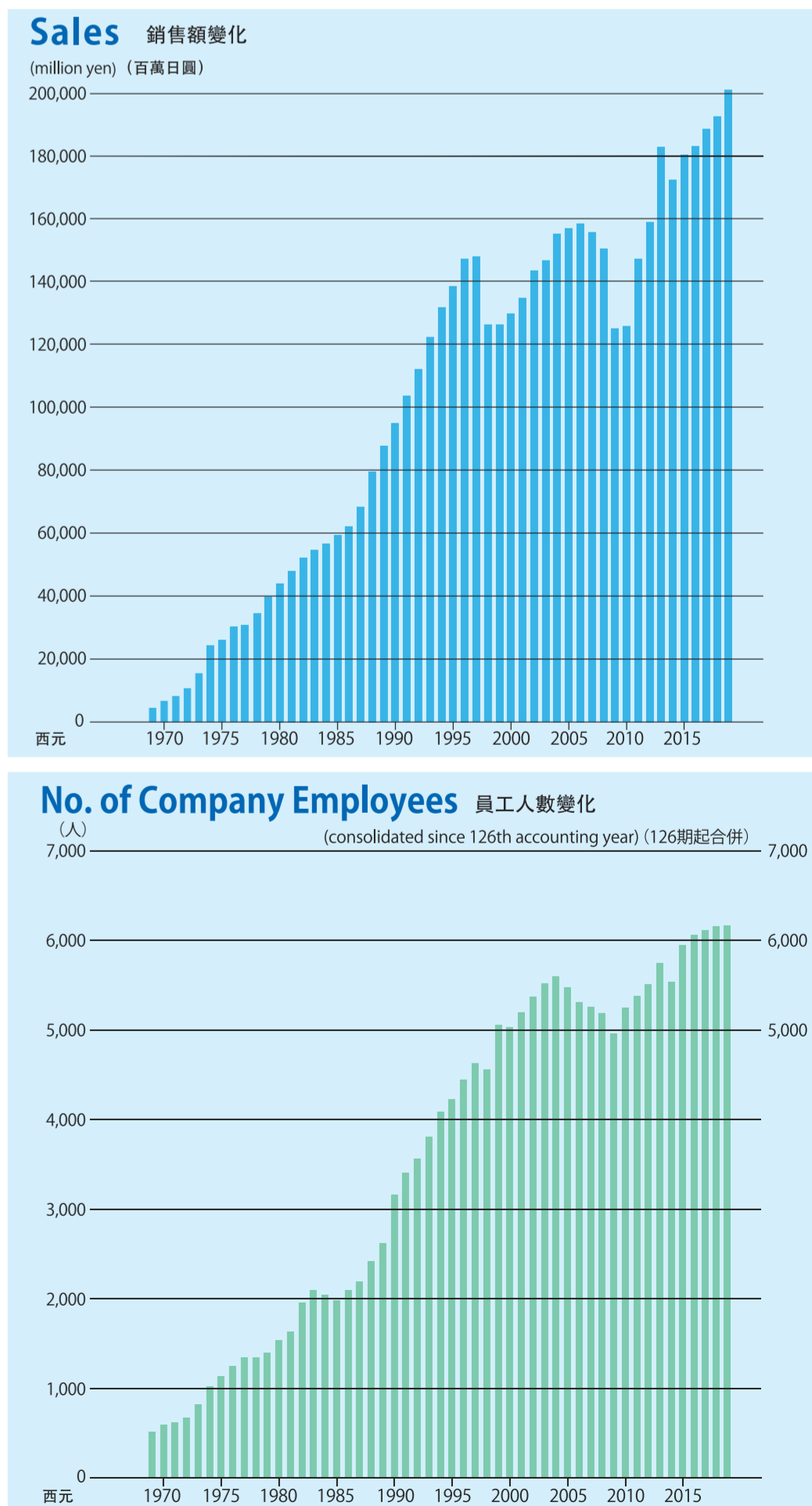

Takara standard

樂軒・幸福由此開始